





HORGANS

Assembly Instructions - Page 1



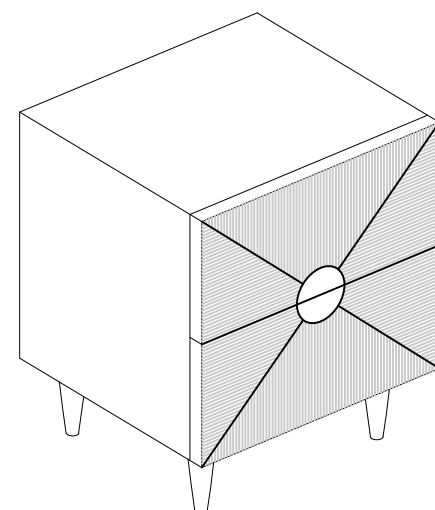
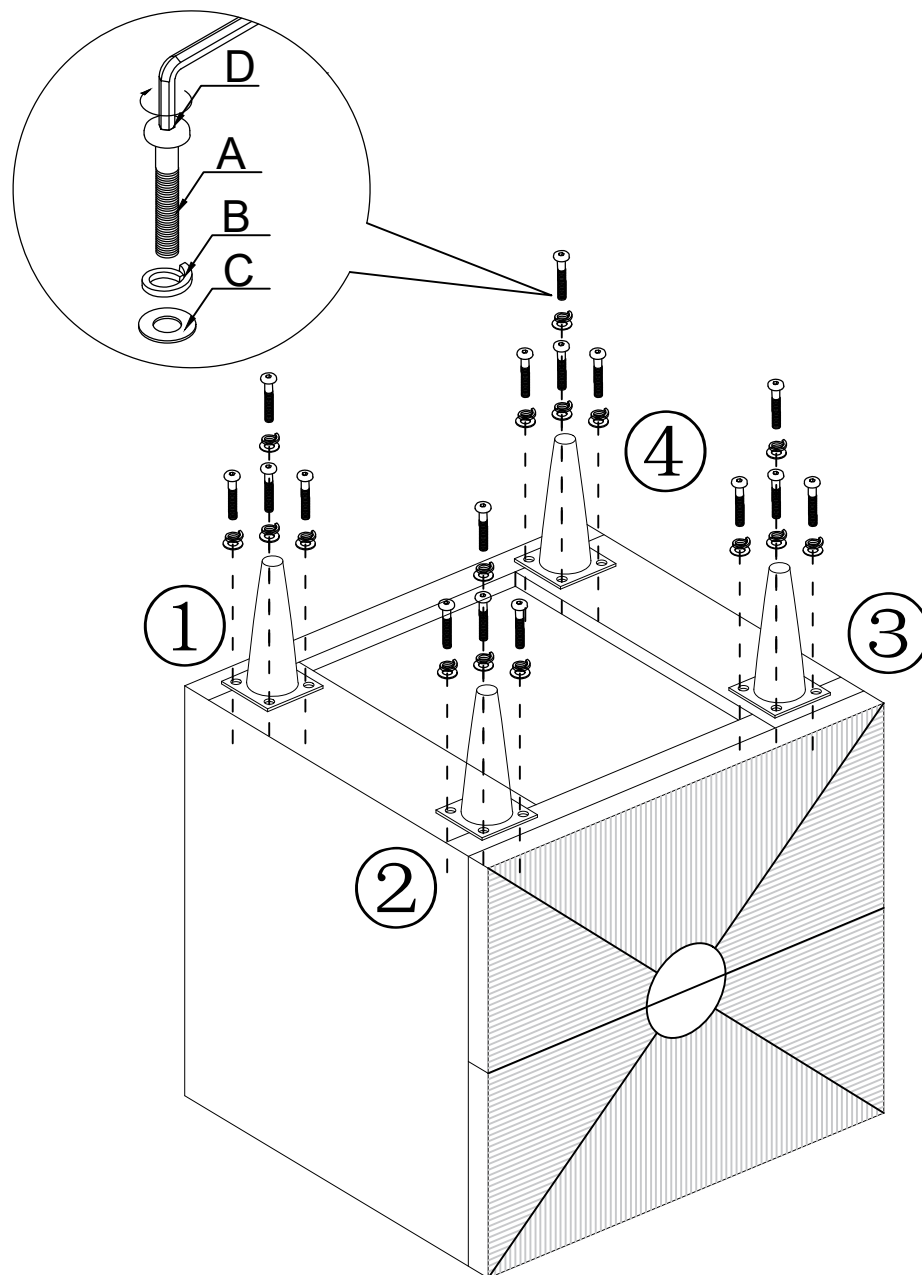

NO.	ITEM	DESCRIPTION	SPEC.	QTY
A		Hexagon bolt	M8x25	16PCS
B		Lock washer	M8	16PCS
C		Washer	16x8	16PCS
D		Allen key	M8	1PC



HORGANS

Assembly Instructions - Page 2

Anti Tip Kit - steps to attach wall anchors

NO.	ITEM	DESCRIPTION	SPEC.	QTY
E		Anti-tip belt		2PCS
F		Screw	M4×20	4PCS
G		Screw	M4×40	4PCS
H		Plastic expansion		4PCS

