

HORGANS

Assembly Instructions

Step 1

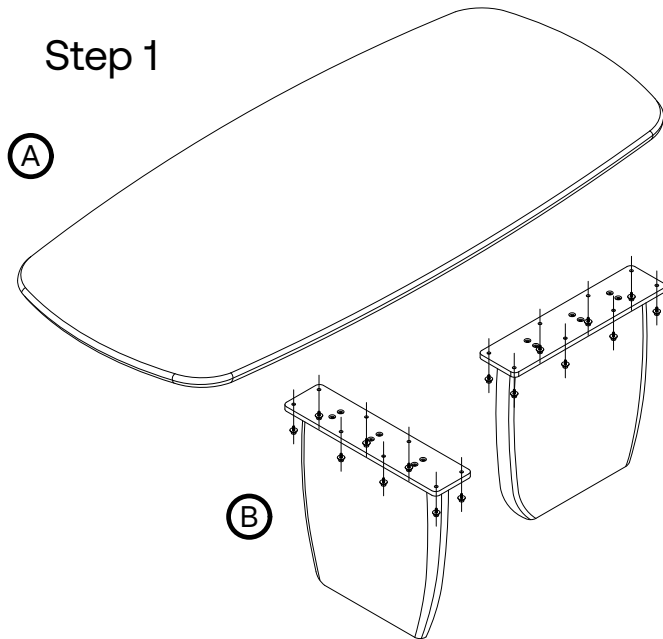



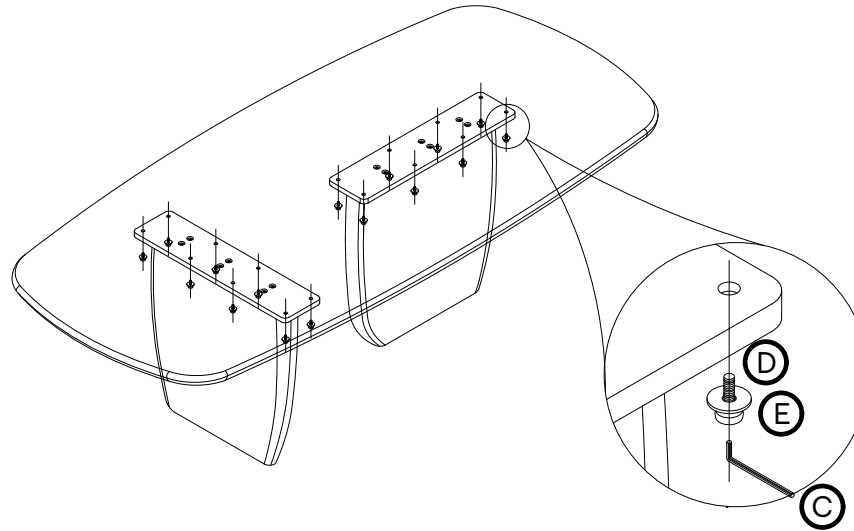

Step 2

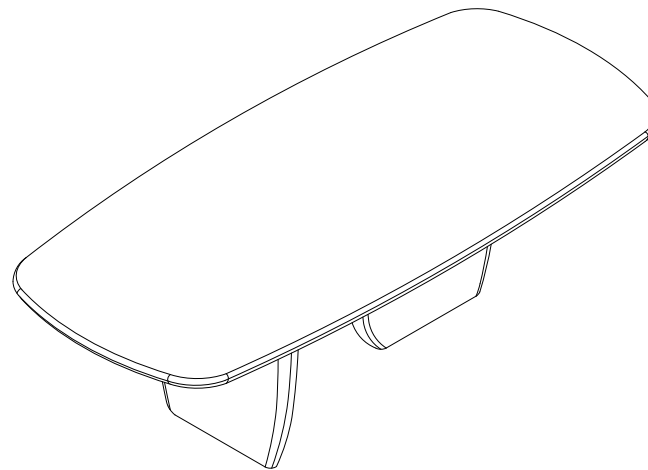

Step 3

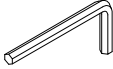

ID	Description	QTY
A	 Top	1
B	 Base	2
C	 L-Key	1
D	 M8x30	16
E	 Washer Ø 20	16